

VEKA EC

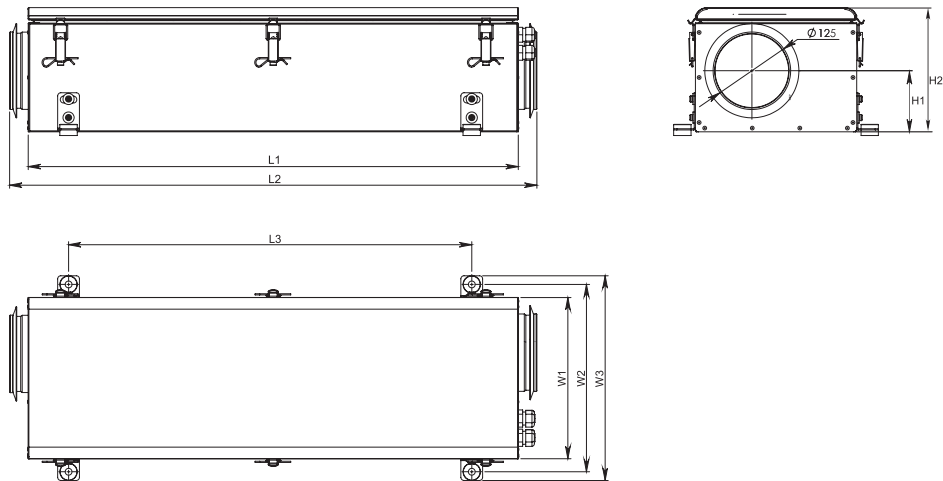







Application	Ventilation of food production and industrial premises, warehouses, sport facilities and similar.
Description	VEKA 350 EC units are a cost-efficient solution for supplying fresh air. Units exceed ErP 2016 requirements. The main benefits of the VEKA EC are efficient EC fans and their compact size. Two types of electrical heaters available for these units.
Controls	All components for fan and heater control should be connected by the user.
The main features	<ul style="list-style-type: none"> › Efficient EC fan (motor consumes less than 55W). › 4 heaters. › Highly compact size: 200x260x790.
Construction	<ul style="list-style-type: none"> › Powder-coated galvanized steel casing. › Acoustic and thermal insulation of external walls - 20 mm. › Efficient EC fan and G4 class filters. › Electric heaters: (1f 2.4/3.6 kW, 2f 3.0/4.5 kW).



Unit	Dimensions [mm]								
	L1	L2	L3	W1	W2	W3	H1	H2	∅D
VEKA 350 EC	790	850	650	260	302	330	99	200	125

Unit	Optional accessories						
	Stouch	MTP010	EKR 6.1	SKG	AKS	AP	RSK
VEKA 350 EC	0-10VDC fan speed control	0-10VDC fan speed control	proportional controller for electric heater	125	125	125	125

Accessories

Remote controller	Speed controller	Controller of electrical heating	Shut-off damper	Circular duct silencer	Mounting clamp	Back draft shutter
						
Stouch p. 176	MTP010 p. 209	EKR 6.1 p. 207	SKG p. 212	AKS p. 216	AP p. 219	RSK p. 214

VEKA EC

VEKA 350 EC

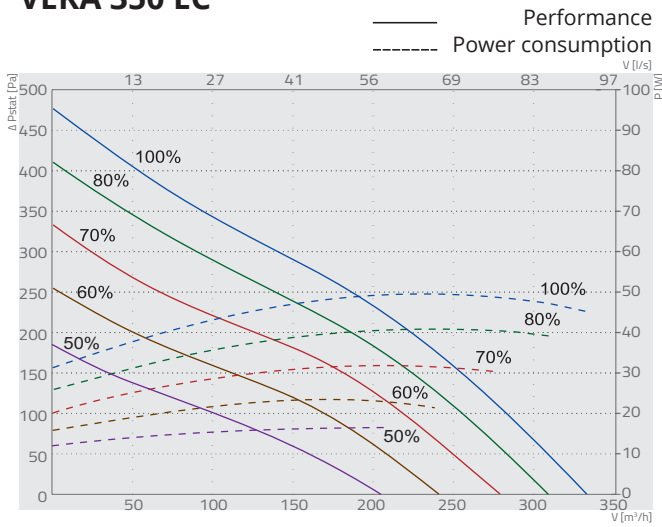

Title	VEKA 350 EC							Article No.	GAGVEKA130_123_0041C
VEKA 350 EC	Lwa total, dB(A)	LWA, dB(A)							
Inlet	65	59	58	55	58	55	52	38	
Outlet	70	61	64	63	62	61	55	42	
Surrounding	46	40	42	37	34	31	28	25	
Measured at 285 m³/h, 100 Pa									

Optional heater	phase/voltage	[50Hz/VAC]	EKA 1f	EKA 2f
	power consumption	[kW]	~1/230	~2/400
	min. airspeed	[m/s]	2,4/10,4	3,0/7,54 4,5/11,3
Fan	phase/voltage	[50Hz/VAC]	~1/230	
	power/current	[kW/A]	0,056/0,46	
	speed	[min ⁻¹]	4385	
min ambient temperature		[°C]	-25	
	protection class	IP	IP-44	
Total power consumption without heater (power/current)		[kW/A]	0,06 /0,46	
Insulation of casing		[mm]	20	
Filter class			G4	
Color		RAL	white (9016)	
Weight (net, without packing)		[kg]	12,91	
Comply with ErP			2016	

AIR HANDLING UNITS

VEKA 350 EC version with electrical heater

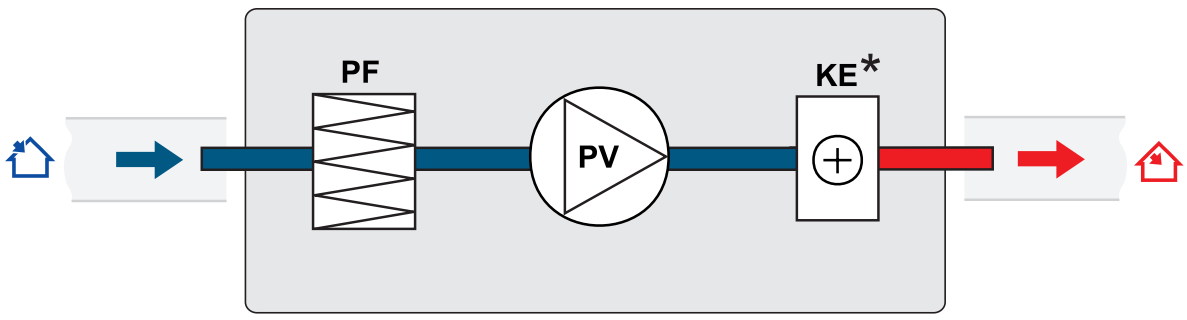

PF - filter for supply air
PV - supply air fan
KE* - electrical heater (supplied separately)